

- High-Resolution Conversion of Light Intensity to Frequency With No External Components
- Programmable Sensitivity and Full-Scale Output Frequency
- Communicates Directly With a Microcontroller
- Single-Supply Operation Down to 2.7 V, With Power-Down Feature
- Absolute Output Frequency Tolerance of $\pm 5\%$ (TSL230BR)
- Nonlinearity Error Typically 0.2% at 100 kHz
- Stable 150 ppm/°C Temperature Coefficient
- Replacements for TSL230, TSL230A, and TSL230B

PACKAGE D
8-LEAD SOIC
(TOP VIEW)

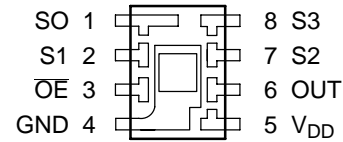

PACKAGE P
8-LEAD PDIP
(TOP VIEW)

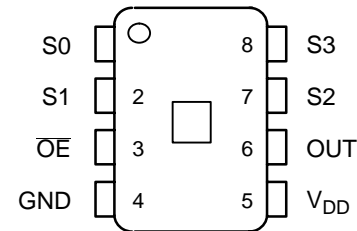

Description

The TSL230R, TSL230AR, and TSL230BR programmable light-to-frequency converters combine a configurable silicon photodiode and a current-to-frequency converter on single monolithic CMOS integrated circuits. The output can be either a pulse train or a square wave (50% duty cycle) with frequency directly proportional to light intensity. Device sensitivity is selectable in three ranges, providing two decades of adjustment. The full-scale output frequency can be scaled by one of four preset values. All inputs and the output are TTL compatible, allowing direct two-way communication with a microcontroller for programming and output interface. An output enable (\overline{OE}) is provided that places the output in the high-impedance state for multiple-unit sharing of a microcontroller input line.

The devices are available with absolute-output-frequency tolerances of $\pm 5\%$ (TSL230BR), $\pm 10\%$ (TSL230AR), or $\pm 20\%$ (TSL230R). They have been temperature compensated for the ultraviolet-to-visible light range of 320 nm to 700 nm and respond over the light range of 320 nm to 1050 nm. The devices are characterized over the temperature range of -25°C to 70°C .

Functional Block Diagram

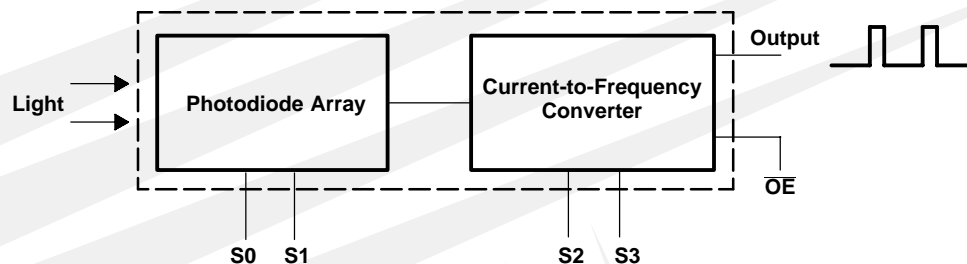

TSL230R, TSL230AR, TSL230BR PROGRAMMABLE LIGHT-TO-FREQUENCY CONVERTERS

TAOS048A – JANUARY 2004

Terminal Functions

TERMINAL NAME	NO.	TYPE	DESCRIPTION
GND	4		Ground
\overline{OE}	3	I	Enable for f_O (active low)
OUT	6	O	Scaled-frequency (f_O) output
S0, S1	1, 2	I	Sensitivity-select inputs
S2, S3	7, 8	I	f_O scaling-select inputs
V_{DD}	5		Supply voltage

Selectable Options

S1	S0	SENSITIVITY
L	L	Power down
L	H	1X
H	L	10X
H	H	100X

S3	S2	f_O SCALING (divide-by)
L	L	1
L	H	2
H	L	10
H	H	100

Available Options

DEVICE	T_A	PACKAGE – LEADS	PACKAGE DESIGNATOR	ORDERING NUMBER
TSL230R	-25°C to 70°	PDIP-8	P	TSL230RP
TSL230AR	-25°C to 70°	PDIP-8	P	TSL230ARP
TSL230BR	-25°C to 70°	PDIP-8	P	TSL230BRP
TSL230R	-25°C to 70°	SOIC-8	D	TSL230RD
TSL230AR	-25°C to 70°	SOIC-8	D	TSL230ARD
TSL230BR	-25°C to 70°	SOIC-8	D	TSL230BRD

Absolute Maximum Ratings over operating free-air temperature range (unless otherwise noted)†

Supply voltage, V_{DD} (see Note 1)	6 V
Input voltage range, all inputs, V_I	-0.3 V to $V_{DD} + 0.3$ V
Operating free-air temperature range, T_A	-25°C to 70°C
Storage temperature range	-25°C to 85°C
Lead temperature 1,6 mm (1/16 inch) from case for 10 seconds	260°C

† Stresses beyond those listed under “absolute maximum ratings” may cause permanent damage to the device. These are stress ratings only, and functional operation of the device at these or any other conditions beyond those indicated under “recommended operating conditions” is not implied. Exposure to absolute-maximum-rated conditions for extended periods may affect device reliability.

NOTE 1: All voltage values are with respect to GND.

Recommended Operating Conditions

	MIN	NOM	MAX	UNIT
Supply voltage, V_{DD}	2.7	5	5.5	V
High-level input voltage, V_{IH}	$V_{DD} = 4.5$ V to 5.5 V		2	V_{DD}
Low-level input voltage, V_{IL}	$V_{DD} = 4.5$ V to 5.5 V		0	0.8
Operating free-air temperature range, T_A	-25		70	°C

TSL230R, TSL230AR, TSL230BR PROGRAMMABLE LIGHT-TO-FREQUENCY CONVERTERS

TAOS048A – JANUARY 2004

Electrical Characteristics at $T_A = 25^\circ\text{C}$, $V_{DD} = 5\text{ V}$ (unless otherwise noted)

PARAMETER		TEST CONDITIONS	MIN	TYP	MAX	UNIT
V_{OH}	High-level output voltage	$I_{OH} = -4\text{ mA}$	4	4.5		V
V_{OL}	Low-level output voltage	$I_{OL} = 4\text{ mA}$		0.25	0.4	V
I_{IH}	High-level input current				5	μA
I_{IL}	Low-level input current				5	μA
I_{DD}	Supply current	Power-on mode		2	3	mA
		Power-down mode		5	12	μA
F.S.	Full-scale frequency [†]		1.1			MHz
	Temperature coefficient of output frequency	$\lambda \leq 700\text{ nm}$		± 150		ppm/ $^\circ\text{C}$
k_{SVS}	Supply voltage sensitivity	$V_{DD} = 5\text{ V} \pm 10\%$		± 0.5		%/V

[†] Full-scale frequency is the maximum operating frequency of the device without saturation.

Operating Characteristics at $V_{DD} = 5\text{ V}$, $T_A = 25^\circ\text{C}$, $E_e = 130\ \mu\text{W}/\text{cm}^2$, $\lambda_p = 640\text{ nm}$ (unless otherwise noted)

PARAMETER	TEST CONDITIONS	TSL230R			TSL230AR			TSL230BR			UNIT	
		MIN	TYP	MAX	MIN	TYP	MAX	MIN	TYP	MAX		
f_O	Output frequency	$S_0 = S_1 = H,$ $S_2 = S_3 = L$	80	100	120	90	100	110	95	100	105	kHz
		$S_1 = H,$ $S_0 = S_2 = S_3 = L$	8	10	12	9	10	11	9.5	10	10.5	kHz
		$S_0 = H,$ $S_1 = S_2 = S_3 = L$	0.8	1	1.2	0.9	1	1.1	0.95	1	1.05	kHz
		$S_0 = S_1 = S_2 = H,$ $S_3 = L$	40	50	60	45	50	55	47.5	50	52.5	kHz
		$S_0 = S_1 = S_3 = H,$ $S_2 = L$	8	10	12	9	10	11	9.5	10	10.5	kHz
		$S_0 = S_1 = S_2 = S_3 = H$	0.8	1	1.2	0.9	1	1.1	0.95	1	1.05	kHz
		$E_e = 0,$ $S_0 = S_1 = H,$ $S_2 = S_3 = L$		0.4	10		0.4	10		0.4	10	Hz
R_e	Responsivity	$S_0 = S_1 = H,$ $S_2 = S_3 = L$		0.77		0.77		0.77			kHz/ ($\mu\text{W}/\text{cm}^2$)	
t_w	Output pulse duration	$S_2 = S_3 = L$	125		600	125		600	125		600	ns
		S_2 or $S_3 = H$		$1/2f_O$		$1/2f_O$		$1/2f_O$			$1/2f_O$	s
Nonlinearity ^{‡#}		$f_O = 0\text{ MHz to }10\text{ kHz}$	$\pm 0.1\%$			$\pm 0.1\%$			$\pm 0.1\%$			%F.S.
		$f_O = 0\text{ MHz to }100\text{ kHz}$	$\pm 0.2\%$			$\pm 0.2\%$			$\pm 0.2\%$			%F.S.
		$f_O = 0\text{ MHz to }1\text{ MHz}$	$\pm 0.5\%$			$\pm 0.5\%$			$\pm 0.5\%$			%F.S.
	Recovery from power down			100		100			100		μs	
	Step response to full-scale step input	1 pulse of new frequency plus $1\ \mu\text{s}$										
	Response time to programming change	2 periods of new principal frequency plus $1\ \mu\text{s}^{\S}$										
	Response time to output enable (OE)		50	150		50	150		50	150	ns	

[‡] Nonlinearity is defined as the deviation of f_O from a straight line between zero and full scale, expressed as a percent of full scale.

[#] Nonlinearity test condition: $S_0 = S_1 = H$, $S_2 = S_3 = L$.

^{\S} Principal frequency is the internal oscillator frequency, equivalent to divide-by-1 output selection.

TSL230R, TSL230AR, TSL230BR PROGRAMMABLE LIGHT-TO-FREQUENCY CONVERTERS

TAOS048A – JANUARY 2004

TYPICAL CHARACTERISTICS

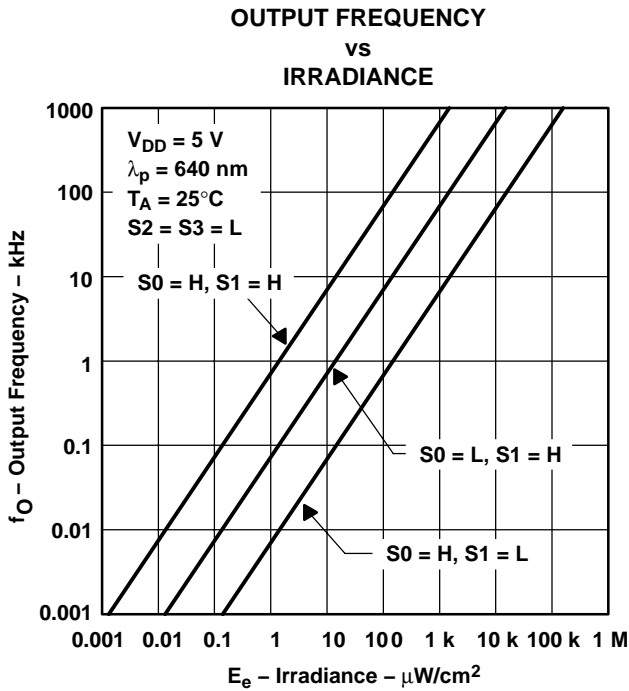

Figure 1

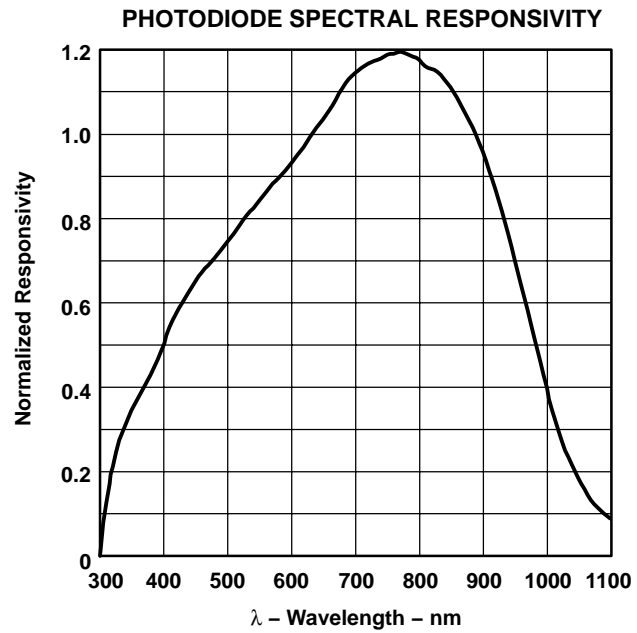

Figure 2

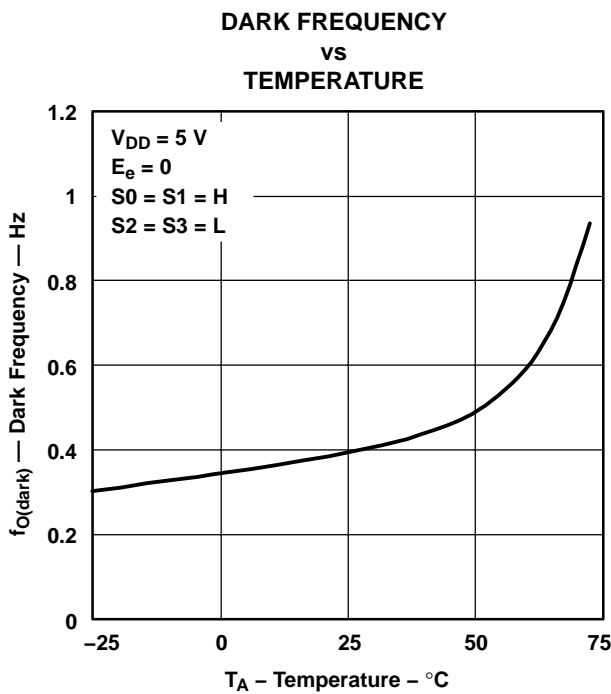

Figure 3

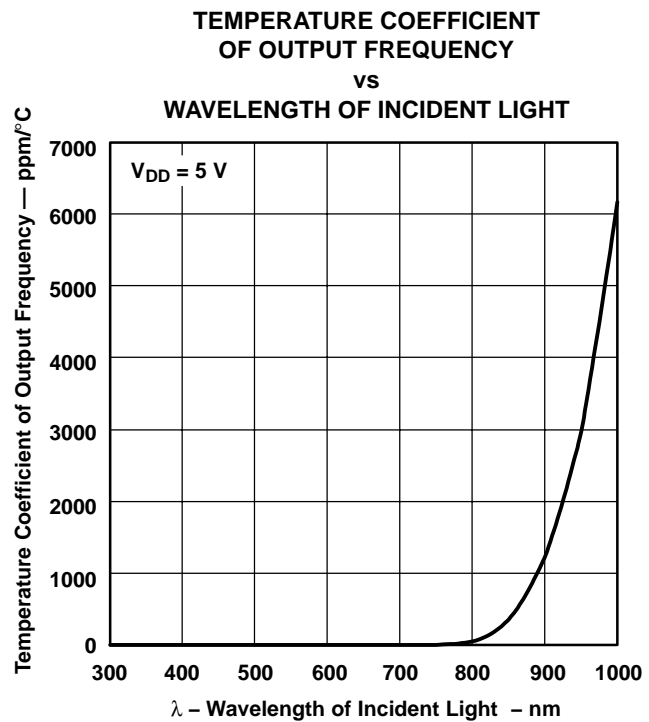

Figure 4

TYPICAL CHARACTERISTICS

OUTPUT FREQUENCY
vs
SUPPLY VOLTAGE

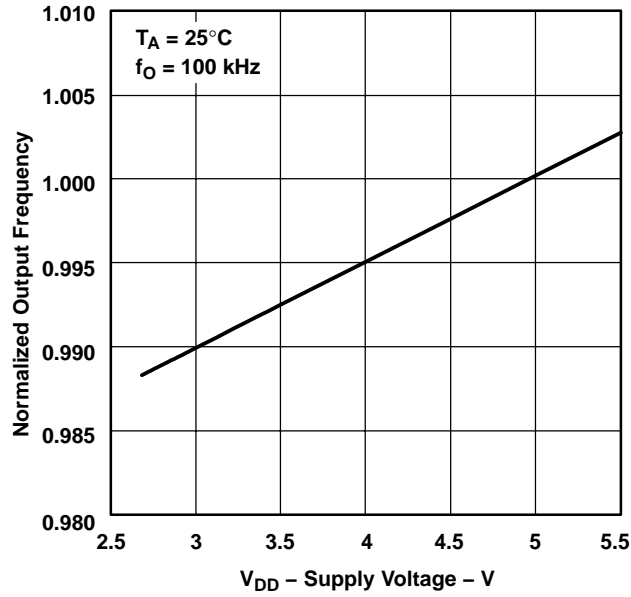

Figure 5

TSL230R, TSL230AR, TSL230BR PROGRAMMABLE LIGHT-TO-FREQUENCY CONVERTERS

TAOS048A – JANUARY 2004

APPLICATION INFORMATION

Power-supply considerations

Power-supply lines must be decoupled by a 0.01- μ F to 0.1- μ F capacitor with short leads placed close to the TSL230 device package. A low-noise power supply is required to minimize jitter on output pulses.

Input interface

A low-impedance electrical connection between the device \overline{OE} pin and the device GND pin is required for improved noise immunity.

Output interface

The output of the device is designed to drive a standard TTL or CMOS logic input over short distances. If lines greater than 12 inches are used on the output, a buffer or line driver is recommended.

Sensitivity adjustment

Sensitivity is controlled by two logic inputs, S0 and S1. Sensitivity is adjusted using an electronic iris technique — effectively an aperture control — to change the response of the device to a given amount of light. The sensitivity can be set to one of three levels: 1 \times , 10 \times or 100 \times , providing two decades of adjustment. This allows the responsivity of the device to be optimized to a given light level while preserving the full-scale output-frequency range. Changing of sensitivity also changes the effective photodiode area by the same factor.

Output-frequency scaling

Output-frequency scaling is controlled by two logic inputs, S2 and S3. Scaling is accomplished on chip by internally connecting the pulse-train output of the converter to a series of frequency dividers. Divided outputs available are divide-by 2, 10, 100, and 1 (no division). Divided outputs are 50 percent-duty-cycle square waves while the direct output (divide-by 1) is a fixed-pulse-width pulse train. Because division of the output frequency is accomplished by counting pulses of the principal (divide-by 1) frequency, the final-output period represents an average of n (where n is 2, 10, or 100) periods of the principal frequency. The output-scaling-counter registers are cleared upon the next pulse of the principal frequency after any transition of the S0, S1, S2, S3, or OE lines. The output goes high upon the next subsequent pulse of the principal frequency, beginning a new valid period. This minimizes the time delay between a change on the input lines and the resulting new output period in the divided output modes. In contrast with the sensitivity adjust, use of the divided outputs lowers both the full-scale frequency and the dark frequency by the selected scale factor.

The frequency-scaling function allows the output range to be optimized for a variety of measurement techniques. The divide-by-1 or straight-through output can be used with a frequency counter, pulse accumulator, or high-speed timer (period measurement). The divided-down outputs may be used where only a slower frequency counter is available, such as a low-cost microcontroller, or where period measurement techniques are used. The divide-by-10 and divide-by-100 outputs provide lower frequency ranges for high resolution-period measurement.

APPLICATION INFORMATION

Measuring the frequency

The choice of interface and measurement technique depends on the desired resolution and data acquisition rate. For maximum data-acquisition rate, period-measurement techniques are used.

Using the divide-by-2 output, data can be collected at a rate of twice the output frequency or one data point every microsecond for full-scale output. Period measurement requires the use of a fast reference clock with available resolution directly related to reference-clock rate. Output scaling can be used to increase the resolution for a given clock rate or to maximize resolution as the light input changes. Period measurement is used to measure rapidly varying light levels or to make a very fast measurement of a constant light source.

Maximum resolution and accuracy may be obtained using frequency-measurement, pulse-accumulation, or integration techniques. Frequency measurements provide the added benefit of averaging out random or high-frequency variations (jitter) resulting from noise in the light signal or from noise in the power supply. Resolution is limited mainly by available counter registers and allowable measurement time. Frequency measurement is well suited for slowly varying or constant light levels and for reading average light levels over short periods of time. Integration (the accumulation of pulses over a very long period of time) can be used to measure exposure, the amount of light present in an area over a given time period.

PCB pad layout

Suggested PCB pad layout guidelines for the plastic dual-in-line D package are shown in Figure 6.

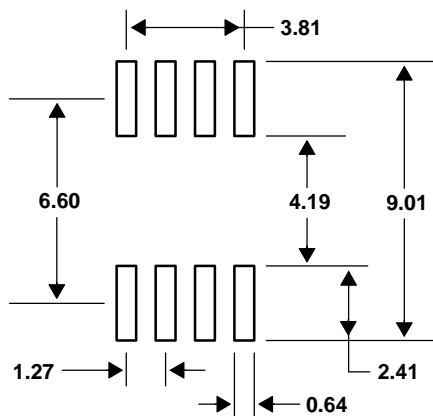

- NOTES: A. All linear dimensions are in millimeters.
 B. This drawing is subject to change without notice.

Figure 6. Suggested D Package PCB Layout

TSL230R, TSL230AR, TSL230BR PROGRAMMABLE LIGHT-TO-FREQUENCY CONVERTERS

TAOS048A – JANUARY 2004

MECHANICAL INFORMATION

This SOIC package consists of an integrated circuit mounted on a lead frame and encapsulated with an electrically nonconductive clear plastic compound. The photodiode area is typically 0.92 mm^2 (0.0014 in^2) ($S_0 = S_1 = H$).

PACKAGE D

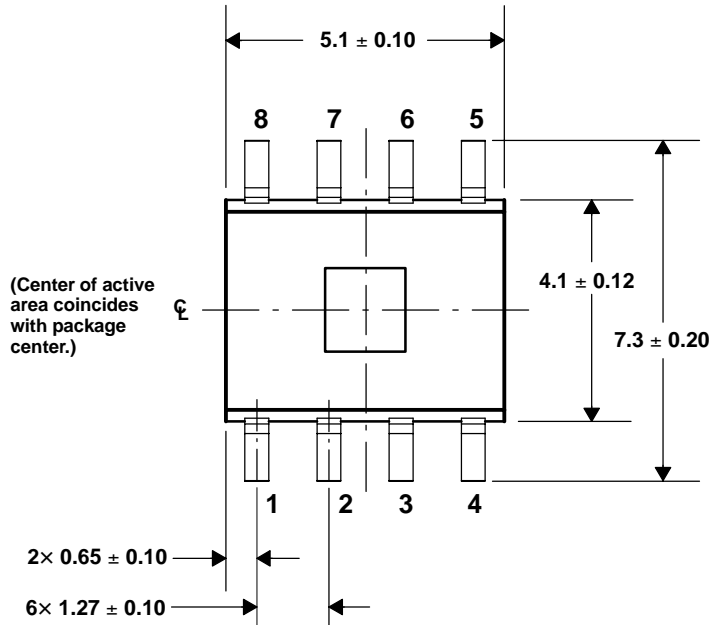

PLASTIC SMALL-OUTLINE PACKAGE

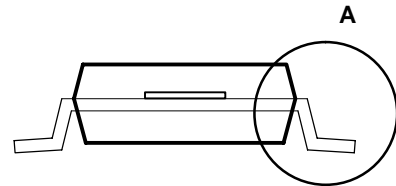
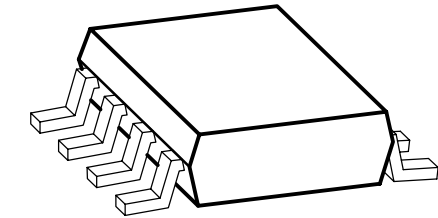

DETAIL A

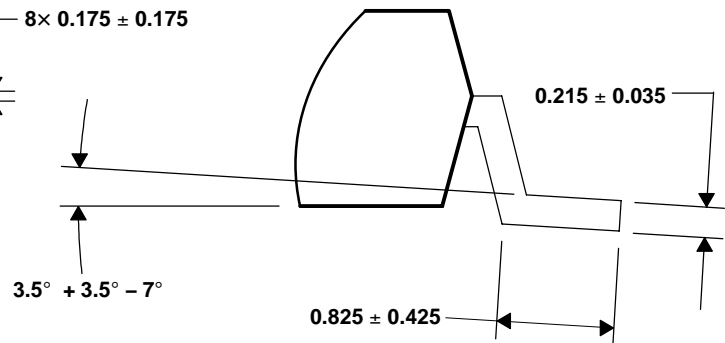

- NOTES:
- All linear dimensions are in millimeters.
 - Package is molded with an electrically nonconductive clear plastic compound having an index of refraction of 1.55.
 - Actual product will vary within the mechanical tolerances shown on this specification. Designs for use of this product **MUST** allow for the data sheet tolerances.
 - Pin 4 (GND) is mechanically connected to the die mount pad.
 - The 8×8 photodiode array area is $1.15 \text{ mm} \times 1.15 \text{ mm}$ (1.33 sq. mm).
 - This drawing is subject to change without notice.

Figure 7. Package D — Plastic Small Outline IC Packaging Configuration

MECHANICAL INFORMATION

PACKAGE P

PLASTIC DUAL-IN-LINE PACKAGE

This dual-in-line package consists of an integrated circuit mounted on a lead frame and encapsulated with an electrically nonconductive clear plastic compound. The photodiode area is typically 0.92 mm² (0.0014 in²) (S0 = S1 = H).

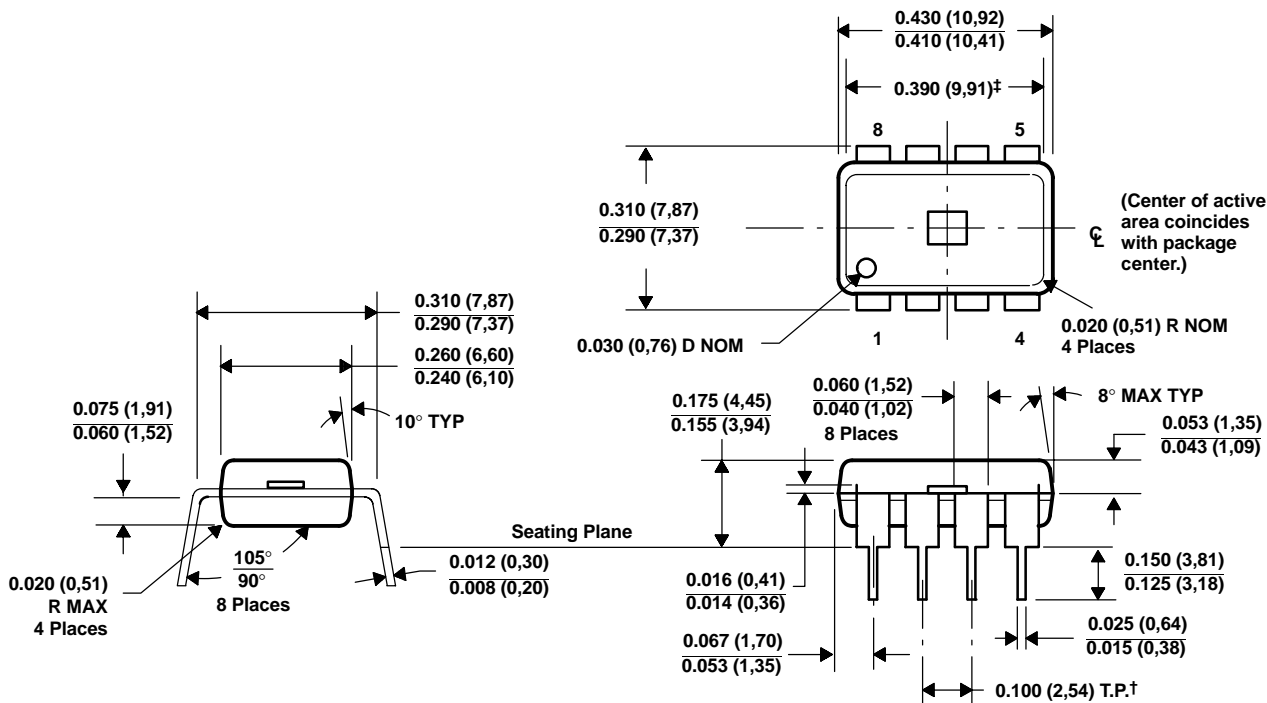

† True position when unit is installed

‡ Minimum flat-optical-surface length

- NOTES: A. All linear dimensions are in inches and parenthetically in millimeters.
 B. Index of refraction of clear plastic is 1.55.
 C. This drawing is subject to change without notice.

Figure 8. Package P — Plastic Dual-In-Line Packaging Configuration

TSL230R, TSL230AR, TSL230BR PROGRAMMABLE LIGHT-TO-FREQUENCY CONVERTERS

TAOS048A – JANUARY 2004

PRODUCTION DATA — information in this document is current at publication date. Products conform to specifications in accordance with the terms of Texas Advanced Optoelectronic Solutions, Inc. standard warranty. Production processing does not necessarily include testing of all parameters.

NOTICE

Texas Advanced Optoelectronic Solutions, Inc. (TAOS) reserves the right to make changes to the products contained in this document to improve performance or for any other purpose, or to discontinue them without notice. Customers are advised to contact TAOS to obtain the latest product information before placing orders or designing TAOS products into systems.

TAOS assumes no responsibility for the use of any products or circuits described in this document or customer product design, conveys no license, either expressed or implied, under any patent or other right, and makes no representation that the circuits are free of patent infringement. TAOS further makes no claim as to the suitability of its products for any particular purpose, nor does TAOS assume any liability arising out of the use of any product or circuit, and specifically disclaims any and all liability, including without limitation consequential or incidental damages.

TEXAS ADVANCED OPTOELECTRONIC SOLUTIONS, INC. PRODUCTS ARE NOT DESIGNED OR INTENDED FOR USE IN CRITICAL APPLICATIONS IN WHICH THE FAILURE OR MALFUNCTION OF THE TAOS PRODUCT MAY RESULT IN PERSONAL INJURY OR DEATH. USE OF TAOS PRODUCTS IN LIFE SUPPORT SYSTEMS IS EXPRESSLY UNAUTHORIZED AND ANY SUCH USE BY A CUSTOMER IS COMPLETELY AT THE CUSTOMER'S RISK.

LUMENOLOGY, TAOS, the TAOS logo, and Texas Advanced Optoelectronic Solutions are registered trademarks of Texas Advanced Optoelectronic Solutions Incorporated.